

Secc. X-X'

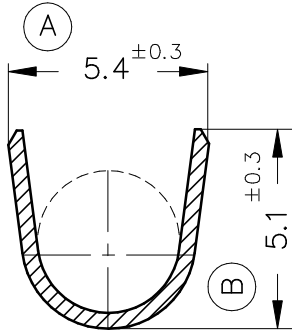

Secc. Z-Z'

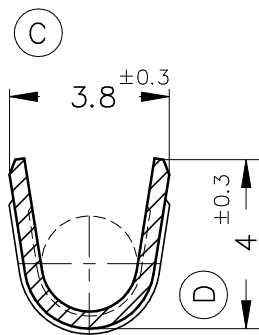

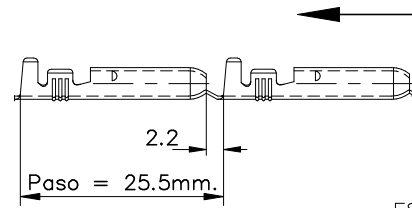

FORMA DE SUMINISTRO

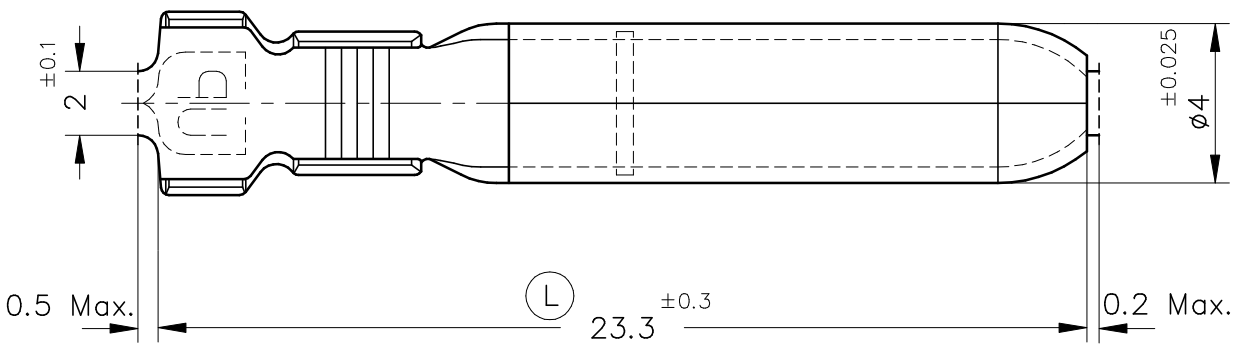
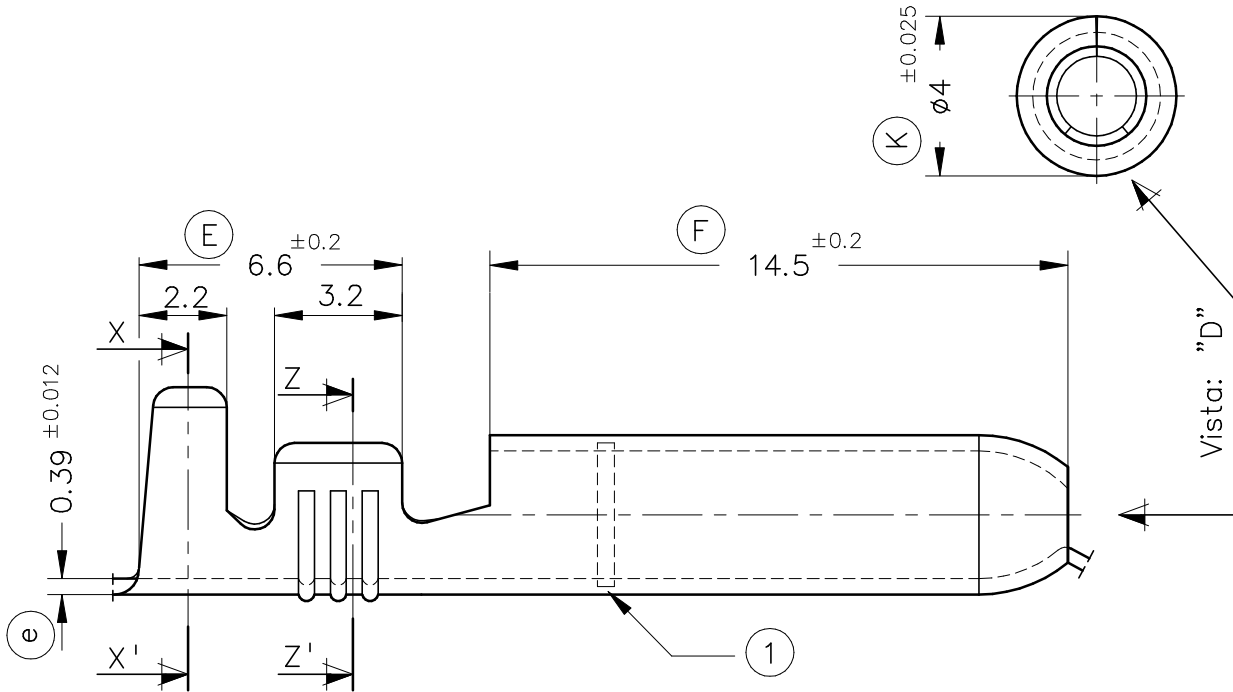

ESC. 1:1



7512.01	Pre-Estañado	Latón	1 ÷ 2.5 mm ²	3 ÷ 4.3 mm.					01	Modif. ①	03/04/03	
7512.00	Natural	CuZn30							00	1ª Edición	10/10/94	
Referencias	Acabados	Material	Sección Conductor	∅ Aislante	Para Macho	A	B	C	D	Rev.	Modificación	Fecha

 ESCUBEDO Especialitats Elèctriques Escubedo S.A.			TERMINAL MACHO de ∅4 mm.						Terminales  Electricos		
DIBUJADO	Gemma	10/10/94	NORMAS MATERIALES			NORMAS DIMENSIONALES			TOLERANCIAS GENERALES		
CONTROL	F.Adamuz	10/10/94	EN1652			Especiales			±0.2 ±2°		
ESCALA	5/1 		REF. 7512.xx								