

SECT. Z-Z'

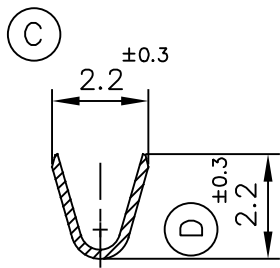

SECT. X-X'

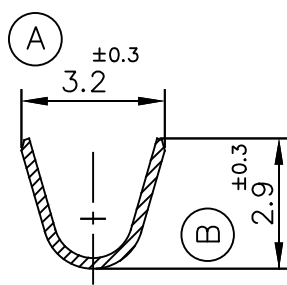

DELIVERED FORM: ON REELS

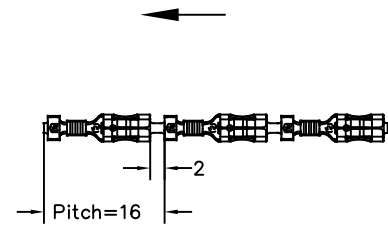

ESC. 1:1

Detalle A
Esc: 10/1

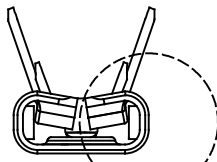
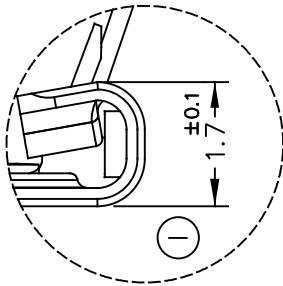

Detalle A

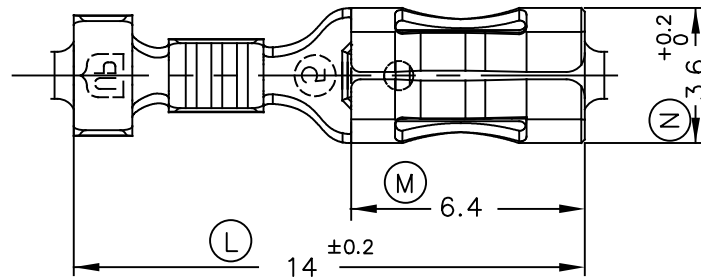
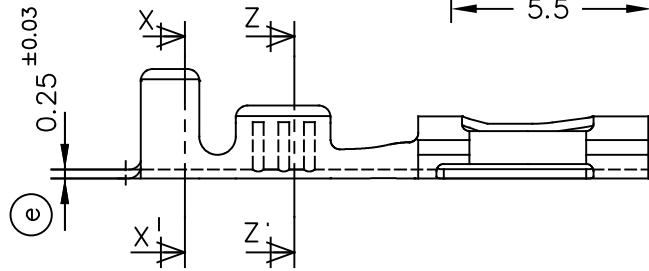
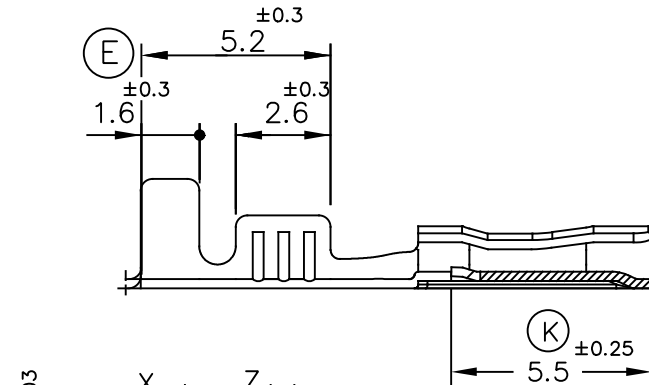

4601.01	Pre Tinplated	Brass CuZn30	0.2-0.6mm ²	1.5+2mm.	2.8x0.5					02	Actualizar caja (DY)	29/07/21
4601.00	Unplated									01	Mod. Section	24/09/19
References	Surface Treat.	Material	Section	∅ Insulation	For tab	A	B	C	D	Rev.	Modificación	Fecha



LOW INSERTION RECEPTACLE
SERIES 2,8mm.



DESIGN	M.Codina	28/06/19	MATERIAL STANDARD EN 1654	DIMENSION STANDARD Special	GENERAL TOLERANCES ±0.2 ±2°	FORMAT	A4v
VERIFY	X.Menac	28/06/19				FILE	PT4601 "c"
SCALE	5/1					REF.	4601.xx