

SECC. D

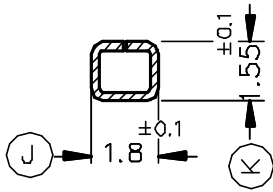

SECC. B-B'

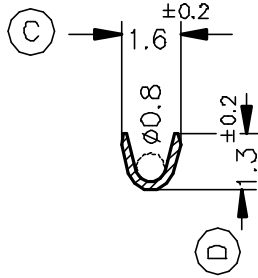

SECC. A-A'

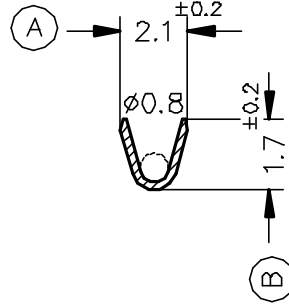

FORMA DE SUMINISTRO

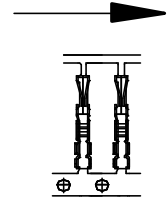

Esc. 1:1

SECC. C

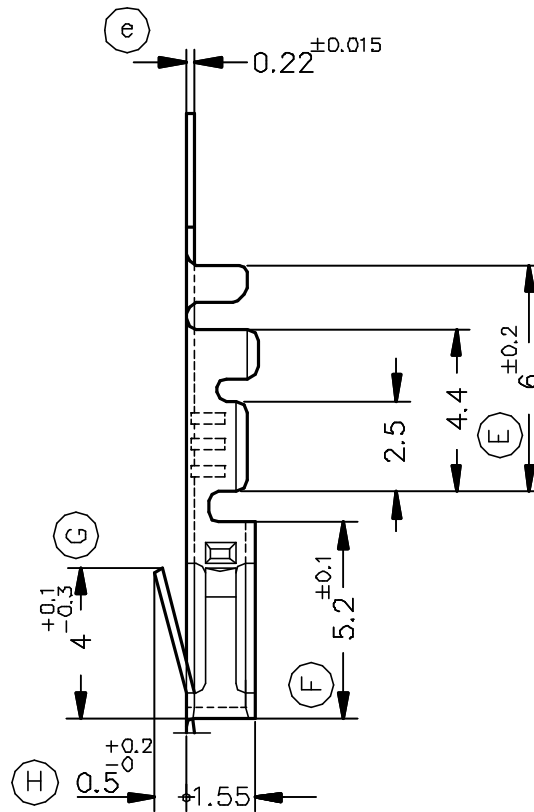
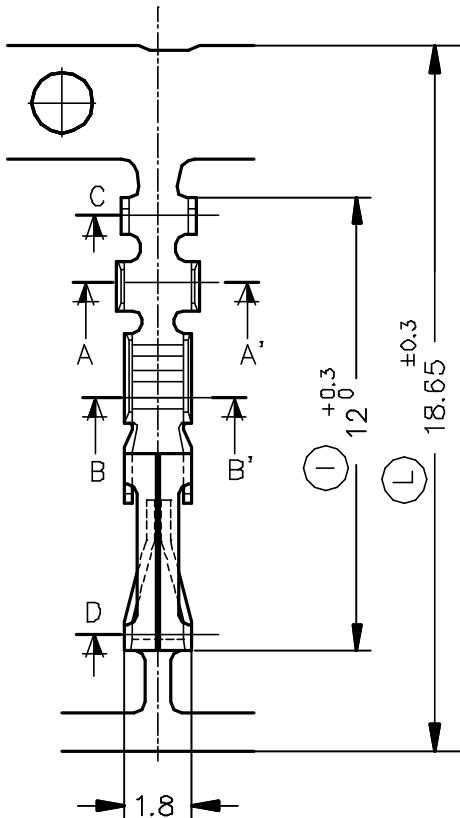
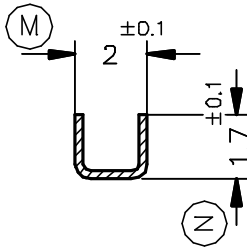

8704.31	Pre-estañado	Bronce CuSn4	0.04÷0.08mm	0.64÷1.27mm	0.62							00	1° Edición	08/03/00
Referencias	Acabados	Material	Sección Conductor	φ Aislante	Para Macho	J	A	B	C	D	Rev.	Modificación	Fecha	



**ESCUBEDO**  
Especialitats Elèctriques Escubedo S.A.

TERMINAL HEMBRA MODU II

Terminales **UP Electricos**

DIBUJADO	Gemma	14/09/99	NORMAS MATERIALES DIN17670		NORMAS DIMENSIONALES Especiales	TOLERANCIAS GENERALES ±0.2 ±2*	FORMATO	A4
CONTROL	F.Adamuz	14/09/99				NOMBRE	PT8704"c"	
ESCALA	5/1					REF.	8704.xx	