

## 5730.\*\*

### 6.3 (.250) TYPE SERIES · FLAGS

#### SELF-LOCKING RECEPTACLES. LOW INSERTION TERMINALS.



**Specification** Self-locking terminals under TP design

**For male (mm)** 6,3x0,8

**Wire size mm<sup>2</sup> (AWG)** 0,5-1 (20-18)

**Materials, temperature and contact resistance**

Part nr.	Material	Finishing	Max. Temp. (°C)	Contact Resist (mΩ)
5730.00	Brass	Natural	110	1.50
5730.01	Brass	Pre-tin-plated	120	0.75
5730.24	Steel	Nickel-plated	300	2.50
5730.51	Cu. Alloy	Pre-tin-plated	150	0.50

**Material thickness (mm)** 0,4

**Max. rated current**

Wire section	5730.00 / 01 / 24 / 51
0.50 mm <sup>2</sup>	8A
0.75 mm <sup>2</sup>	10A
1.00 mm <sup>2</sup>	12A

**Insertion / Withdrawal forces**

	5730.00 / 01 / 51	5730.24
1st Insertion (max)	25N <sup>1</sup>	35N <sup>1</sup>
1st Withdrawal (max)	25N <sup>1</sup>	35N <sup>1</sup>
1st Withdrawal (min, locking enabled)	90N <sup>1</sup>	90N <sup>1</sup>

<sup>1</sup> Valid for Natural Brass Tab

**Security function**

Self-locking function prevents disconnection by pulling the cable. Disconnection is possible disabling the locking function, pressing the lever manually or sliding the connector (see withdrawal forces). It allows several connections-disconnections maintaining the functional features.

**Application tool**

MN5730

**Crimping parameters & pull out force**

Wire section (±10%)	Conductor 		Insulator	Pull-out force (N)
	Height (mm)	Width (mm)	Width (mm)	
0.50 mm <sup>2</sup>	1.30 (±0.03)	2.37 (±0.03)	3.25 (±0.10)	56N @ 60s
0.75 mm <sup>2</sup>	1.40 (±0.05)	2.38 (±0.05)	3.25 (±0.10)	84N @ 60s
1.00 mm <sup>2</sup>	1.50 (±0.05)	2.37 (±0.05)	3.27 (±0.10)	108N @ 60s

Values only valid for the application tool specified upwards. The insulator widths are only indicative as they are dependent on the sheath thickness of the wire used.

**Winding number**

3000

**Compatible connectors**

26433\*\*

**Approved regulations**

Part nr.	Approval	Standard	File	Certified framework
5730.00	UL	UL 310	E211727	AWG 20-18 (10-16 Stranded Cu) / MN5730
5730.01	UL	UL 310	E211727	AWG 20-18 (10-16 Stranded Cu) / MN5730
5730.24	UL	UL 310	E211727	AWG 20-18 (10-16 Stranded Cu) / MN5730

**5730.\*\***

**6.3 (.250) TYPE SERIES · FLAGS**

**SELF-LOCKING RECEPTACLES. LOW INSERTION TERMINALS.**



**Approvals**



**Drawing**

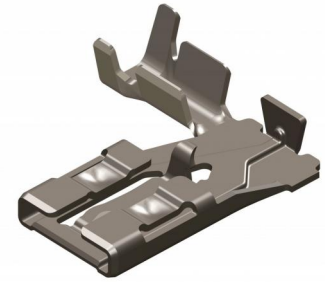
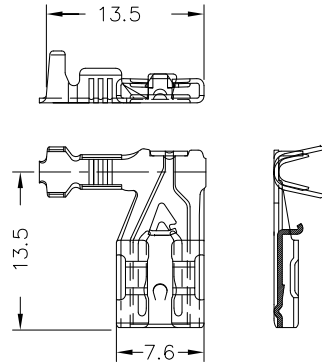

**5730.00 NATURAL BRASS**



**6.3 (.250) TYPE SERIES · FLAGS**

SELF-LOCKING RECEPTACLES. LOW INSERTION TERMINALS.

**Derating curve**

Current carrying capacity vs. Ambient temperature

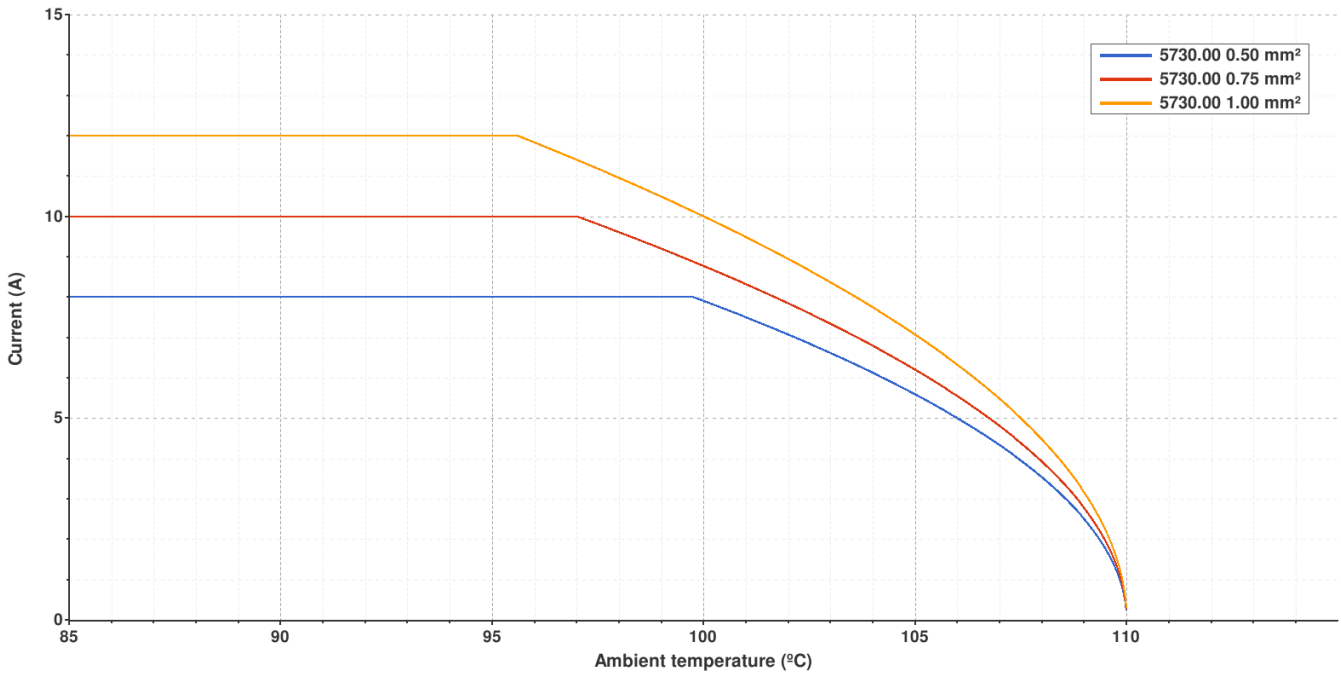

**Temperature rise curve**

Terminal temperature rise due to the current carried

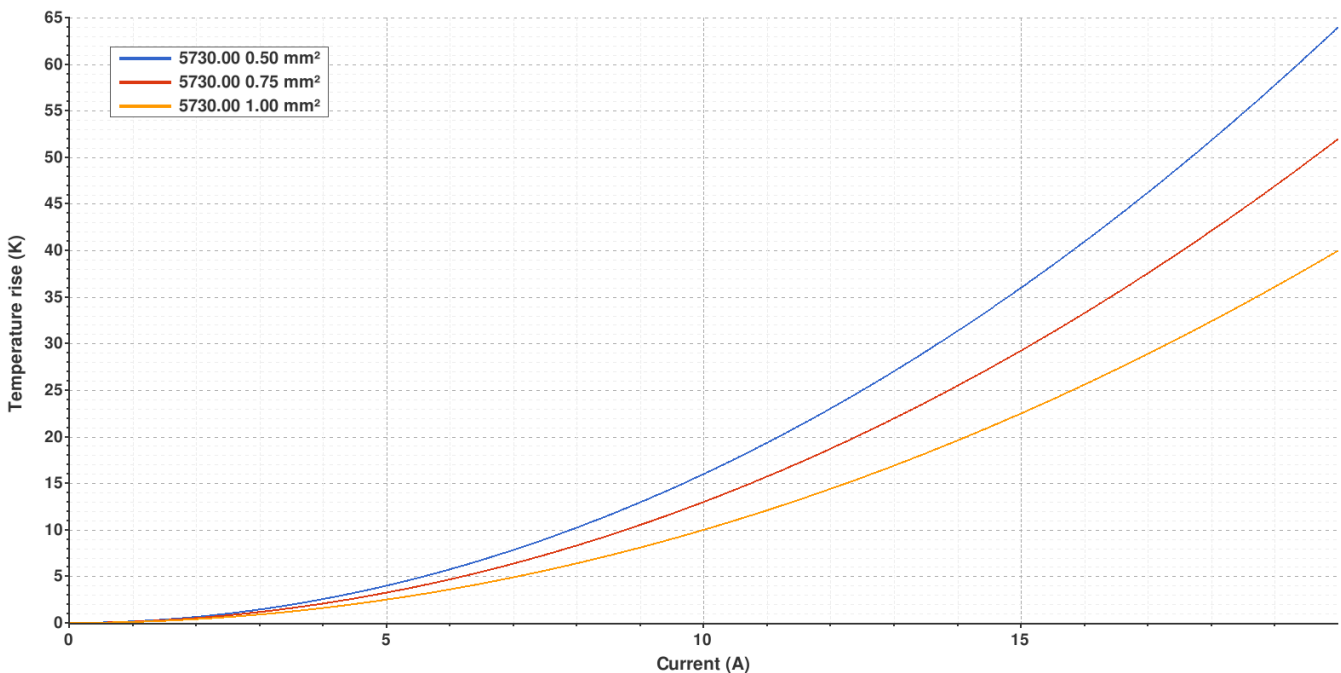

Valid for Natural Brass Tab

**5730.01 PRE-TIN-PLATED BRASS**



**6.3 (.250) TYPE SERIES · FLAGS**

**SELF-LOCKING RECEPTACLES. LOW INSERTION TERMINALS.**

**Derating curve**

Current carrying capacity vs. Ambient temperature

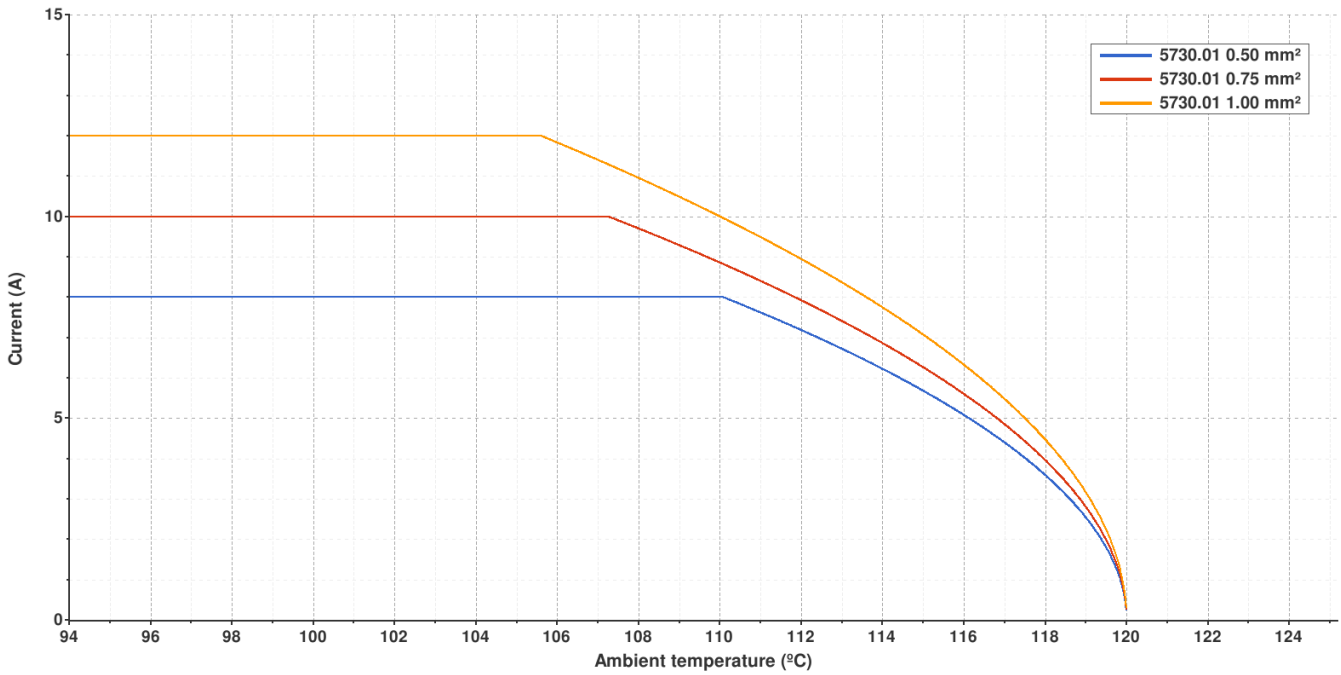

**Temperature rise curve**

Terminal temperature rise due to the current carried

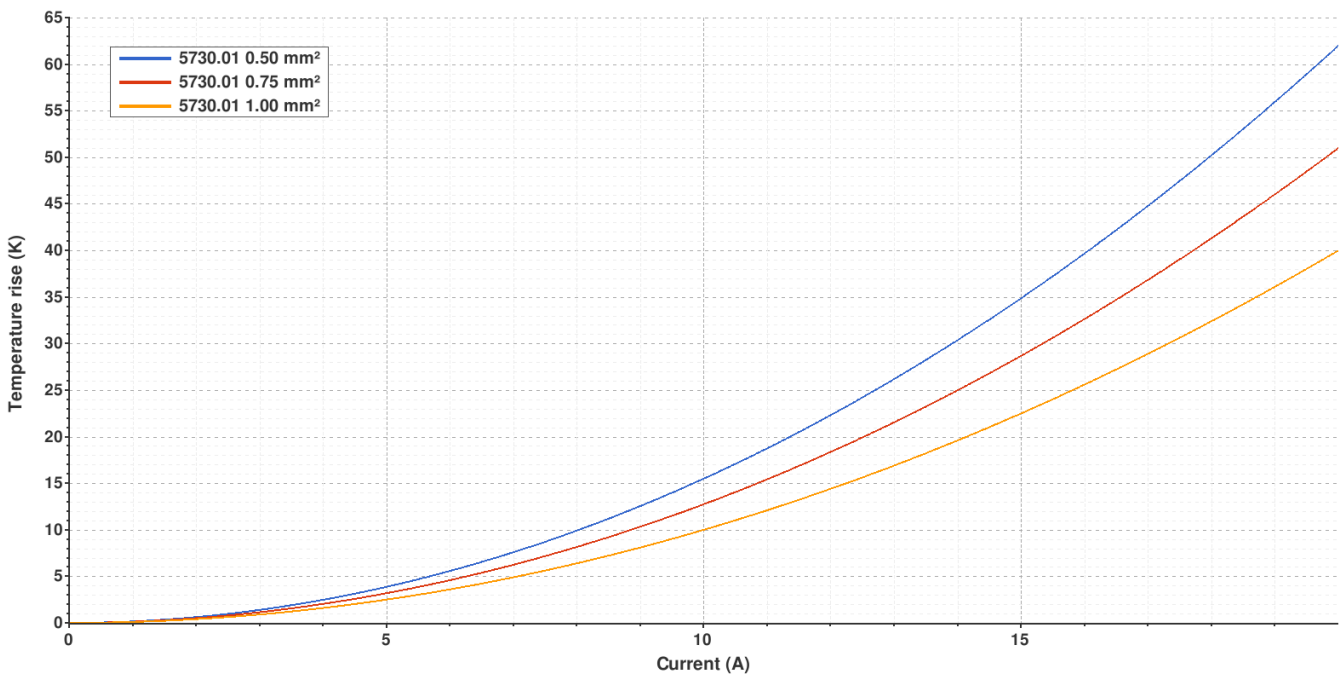

Valid for Natural Brass Tab

**5730.24 NICKEL-PLATED STEEL**



**6.3 (.250) TYPE SERIES · FLAGS**  
SELF-LOCKING RECEPTACLES. LOW INSERTION TERMINALS.

**Derating curve** Current carrying capacity vs. Ambient temperature

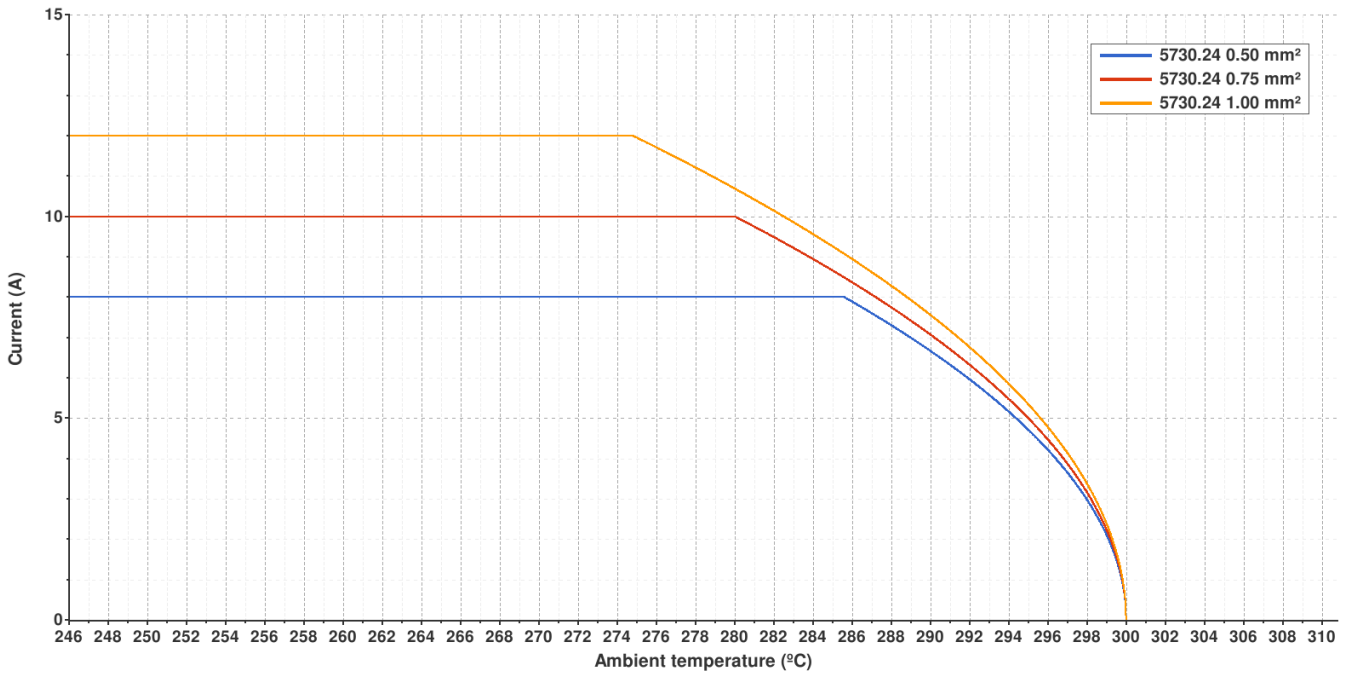

**Temperature rise curve** Terminal temperature rise due to the current carried

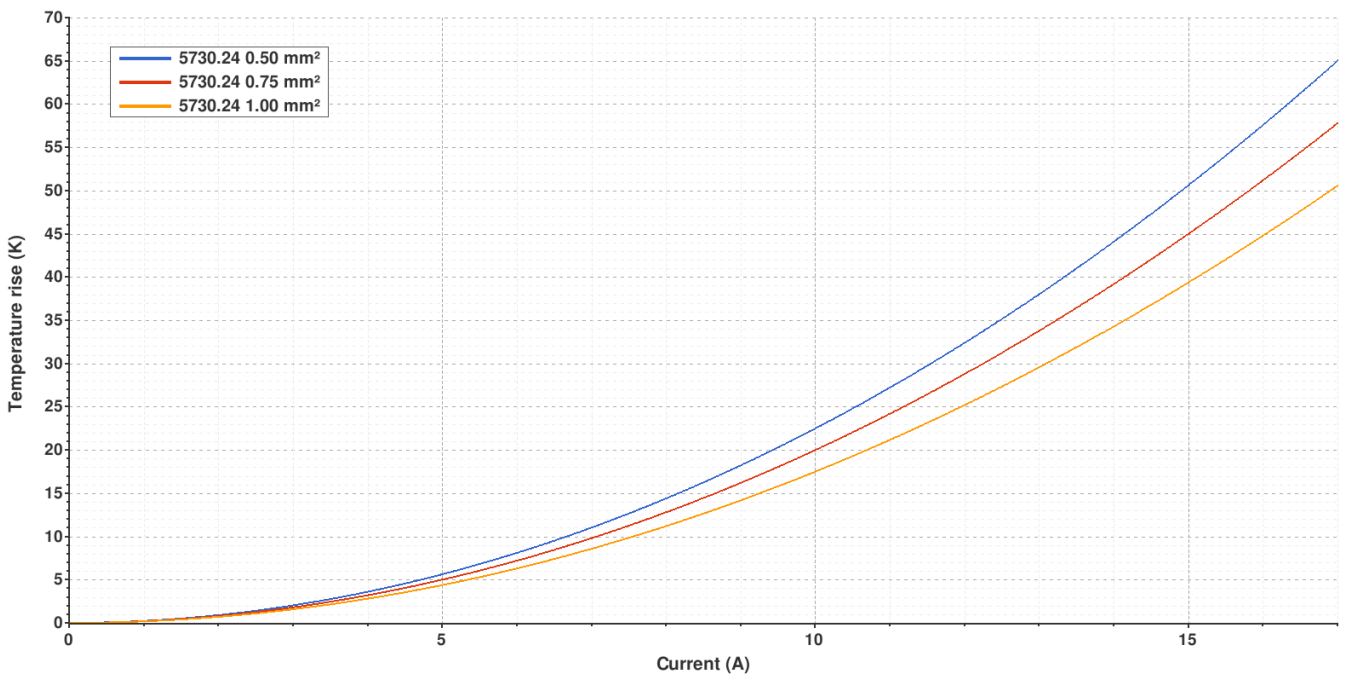

Valid for Natural Brass Tab

**5730.51 PRE-TIN-PLATED CU. ALLOY**



**6.3 (.250) TYPE SERIES · FLAGS**

**SELF-LOCKING RECEPTACLES. LOW INSERTION TERMINALS.**

**Derating curve**

Current carrying capacity vs. Ambient temperature

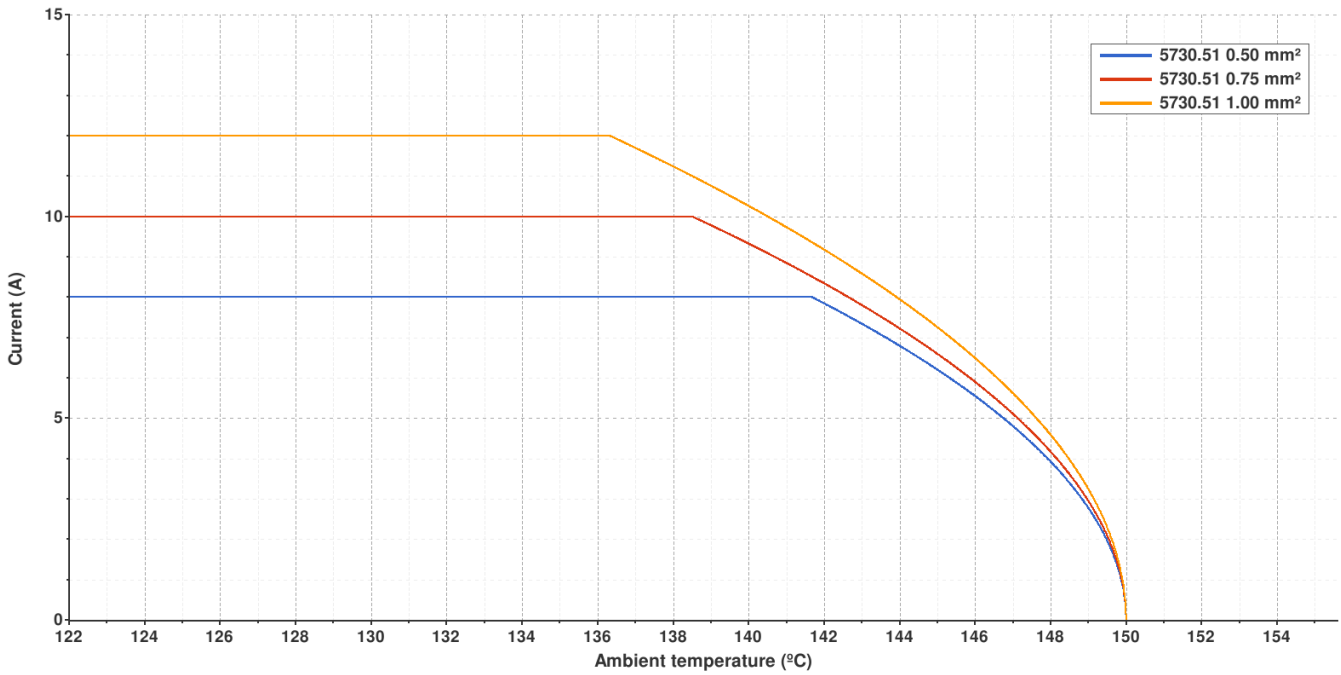

**Temperature rise curve**

Terminal temperature rise due to the current carried

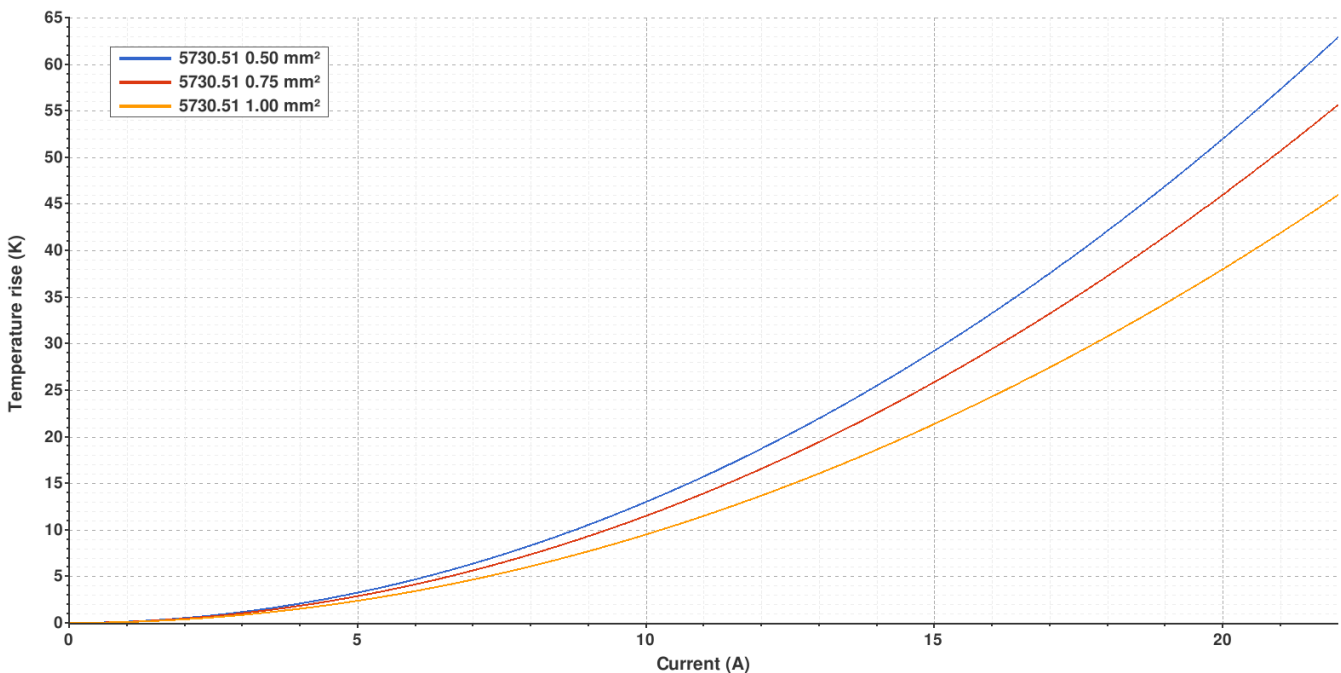

Valid for Natural Brass Tab

**5730.\*\*****6.3 (.250) TYPE SERIES · FLAGS****SELF-LOCKING RECEPTACLES. LOW INSERTION TERMINALS.****Disclaimer**

Data obtained from Escubedo Laboratory essays, using own methodology, cablings, equipment and original crimping tools, done in laboratory conditions and following the indicated standards, errors and omissions excepted. This document has no contractual meaning and it is publicised only for informative purposes. It can be changed without prior notice. The end customer has the sole responsibility to check these characteristics in its environment and with its own components, manufacturing methods and equipment. See also the full range product overview if available. For further information please visit our web site or contact us

Rev. Nr.	Concept	Date	Created/Revised	Approved
A3	Change company name and logo	2021-10-21	Laboratory Dept.	E. Roura
A2	Update de-rating curves	2018-11-27	Laboratory Dept.	E. Roura
A1	Datasheet generated automatically [A1]	2018-09-19	Laboratory Dept.	E. Roura