



3380.**
RING TERMINALS · WITH INSULATION SUPPORT



Specification	7 mm Plate
Description	Squared plate
Ø (mm)	3,2
Wire size mm² (AWG)	0,75-2 (18-14)
Ø Insulation (mm)	2,5-3,5

Materials, temperature and contact resistance

Part nr.	Material	Finishing	Max. Temp. (°C)
3380.00	Brass	Natural	110
3380.02	Brass	Tin plated	120
3380.24	Steel	Nickel-plated	300
3380.30	Bronze	Natural	120
3380.32	Bronze	Tin plated	130

Material thickness (mm)	0,5
Application tool	MN3370
Wire strip length	4.5 (±0.3) mm

Crimping parameters & pull out force

Wire section (±10%)	Conductor		Insulator	Pull-out force (N)
	Height (mm)	Width (mm)		
0.75 mm ²	1.75 (±0.05)	3.27 (±0.05)	4.21 (±0.10)	84N @ 60s
1.00 mm ²	1.85 (±0.05)	3.27 (±0.05)	4.22 (±0.10)	108N @ 60s
1.50 mm ²	2.00 (±0.05)	3.28 (±0.05)	4.25 (±0.10)	150N @ 60s
2.00 mm ²	2.10 (±0.05)	3.29 (±0.05)	4.28 (±0.10)	150N @ 60s

Values only valid for the application tool specified upwards. The insulator widths are only indicative as they are dependent on the sheath thickness of the wire used.

Winding number	7000
-----------------------	------

Approvals



Drawing

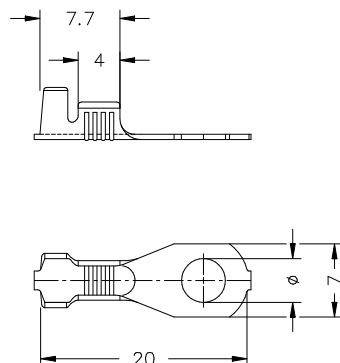



3380.**
RING TERMINALS · WITH INSULATION SUPPORT



Disclaimer

Data obtained from Escubedo Laboratory essays, using own methodology, cablings, equipment and original crimping tools, done in laboratory conditions and following the indicated standards, errors and omissions excepted. This document has no contractual meaning and it is publicised only for informative purposes. It can be changed without prior notice. The end customer has the sole responsibility to check these characteristics in its environment and with its own components, manufacturing methods and equipment. See also the full range product overview if available. For further information please visit our web site or contact us

Rev. Nr.	Concept	Date	Created/Revised	Approved
A1	Datasheet generated automatically [A1]	2018-10-01	Laboratory Dept.	E. Roura

Especialitats Elèctriques Escubedo S.A.U. · Ctra. de Girona-Olot Km. 35,5 · 17843 Riudellots de la Creu · Girona · Spain
Tel.: 34 972 171 706 · Fax: +34 972 171 714 · info@escubedo.com · www.escubedo.com